

Vacuum drying chambers



VD | VDL series





Vacuum drying chambers

Series VD

Page 6

Series VDL

Page 11

Both BINDER vacuum drying chamber models enable effective drying without residue or damaging the material being dried. With their proven technological features, they excellently address the strict requirements of industrial and scientific laboratories. Samples and similar materials incorporating flammable and non-flammable solvents can be dried, depending on the individual use. The chambers use a unique safety design that, together with accustomed outstanding performance, sets the bar in terms of quality and safety.

PRODUCT SELECTION VACUUM DRYING CHAMBERS

Features	Series VD › Page 6	Series VDL › Page 11
Model		
Model 23	•	•
Model 56	•	•
Model 115	•	•
General data		
Temperature range +9 °C above ambient temperature to [°C]	220	110
For flammable solvents (ATEX)	–	•
Ethernet interface	•	•
Controller and timer functions		
Controller display	LCD	TFT Touch
Ramp function	•	•
Time delayed OFF	•	•
Time delayed ON	•	•
Temperature dependent delayed OFF	•	•
Programming option	•	•
Weekly program function	•	•
Real-time clock	•	•
Temperature alarm, visual	•	•

•Standard equipment

ADVANTAGES AT A GLANCE

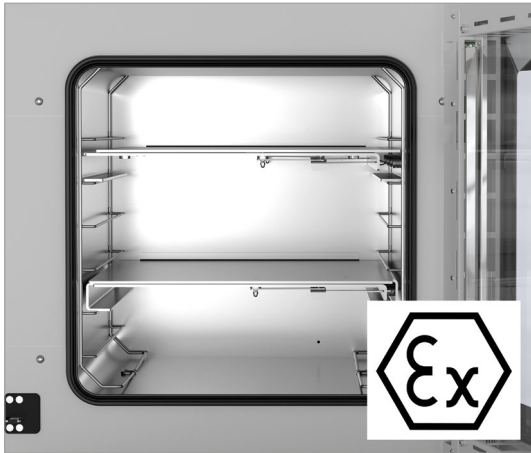

EXPLOSION-PROTECTED INTERIOR

Series VDL

thanks to the ATEX-compliant unit concept with pressure control device for heating activation at a vacuum of < 100 mbar. The unit conforms to ATEX category EX II 2/3/- G IIB T3 Gb/Gc/- X.

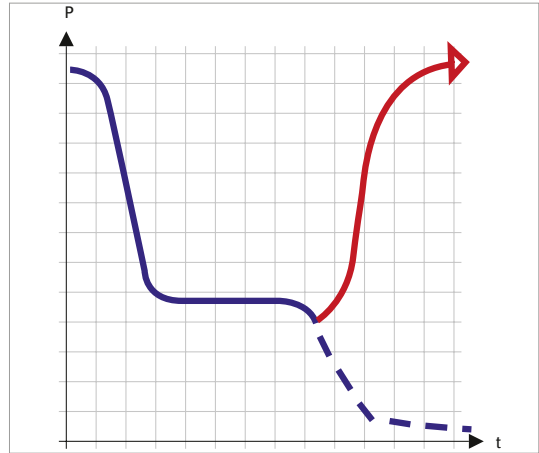

AUTOMATIC DRYING DETECTION

Series VD, VDL

Thanks to the program control, the second pressure drop that typically takes place at the end of drying is detected and the interior is automatically ventilated.

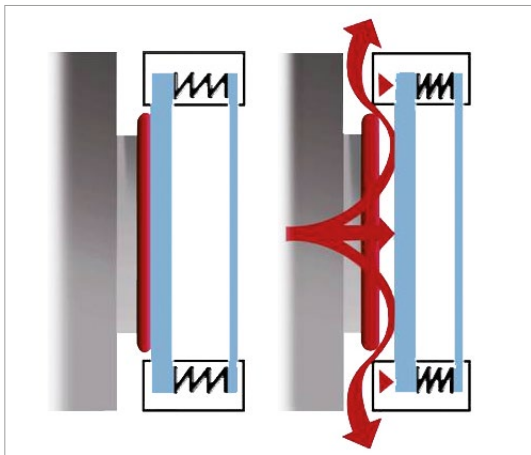

TESTED SAFETY

Series VD, VDL

thanks to the shatterproof, spring-mounted safety glass panel, inert gas connection for interior flushing, and electronic components decoupled from the interior.

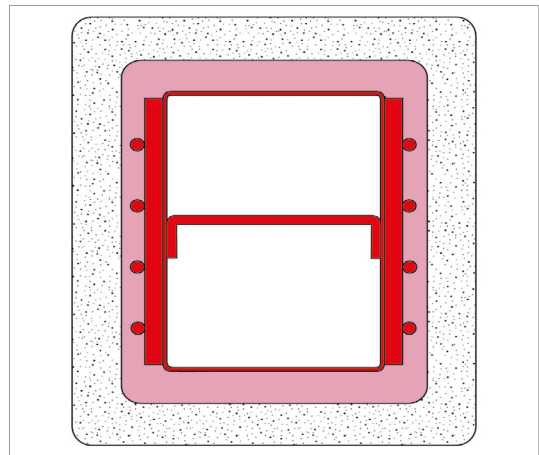

JACKET HEATING

Series VD, VDL

optimum heat transfer thanks to patented expansion racks providing flexible placement for precise temperature control.

Series VD | for non-flammable solvents

BINDER's VD series vacuum drying chambers while deliver impressive performance through their precise temperature control and gentle drying. The patented expansion rack technology from BINDER also ensures optimal heat transfer. The shelves provide flexible placement and are easy to dry in the interior of the chamber.



VD 56 model

BENEFITS

- Fast, gentle drying
- Optimum heat transfer through large thermal conducting plates
- Safe work thanks to proven safety concept
- Also option of modular complete system with vacuum pump and pump chamber

MAIN FEATURES

- Temperature range: ambient temperature +9 °C to +220 °C
- Controller with digital display of pressure and temperature
- Program-controlled drying monitoring with automatic ventilation at end of process
- Internal data logger, measured values can be read out in open format via USB
- 1 aluminum expansion rack, can be custom-positioned
- Inert gas connection
- Shatterproof, spring-mounted safety glass panel
- Large viewing window with option of interior lighting
- Computer interface: Ethernet
- 2 relay outputs, 24 V DC (max. 0.4 A)

AVAILABLE SIZES











Model	Interior volume [L]	Online data sheets
VD 23	24	> go2binder.com/en-VD23
VD 56	55	> go2binder.com/en-VD56
VD 115	119	> go2binder.com/en-VD115

i TIPS & TRICKS

Benefit from our many years of experience, as demonstrated in our technical papers:

Tips & Tricks: > go2binder.com/en-tips-tricks
 Case Studies: > go2binder.com/en-case-studies

OPTIONAL EQUIPMENT

Touchscreen controller	Large display panel with intuitive operation, actual and set values of main process parameters are shown simultaneously on the display. In addition, the graphic chronological evaluation of process parameters is displayed.	
Expansion racks	The expansion racks ensure maximum heat transfer to the items to be dried. You can choose between aluminum and stainless steel racks.	
Analogue output for temperature and pressure	For external monitoring and evaluation of process parameters, option of integration into on-site systems.	
Universal ventilation	For the convenient selection of different ventilation types, with air or inert gas. The valves can be actuated in a targeted manner via the controller or the APT-COM Multi Management Software.	
Universal access port DN 40	For inserting and positioning sensors or supply lines in the vacuum chamber.	
Pump module with vacuum pump	The pump module lifts your vacuum oven to the optimum working height, it also significantly reduces the noise of the vacuum pump and protects the pump and glass material from mechanical damage. The pump in the module can be switched on and off using a switchable socket via the control of the vacuum furnace.	
Vacuum pumps	Our range of membrane pumps, chemistry membrane pumps, or speed-controlled chemistry membrane pumps is perfectly matched to the BINDER vacuum chambers in question. When connected to the pump chamber, the vacuum pump and flask are protected against mechanical damage.	
Multi Management Software APT-COM	Software for managing, recording and documenting device parameters is available in three versions: Basic, Professional and GLP.	
Services	You can access our installation, maintenance, calibration, validation, or warranty services by taking out a Maintenance Service Agreement or by simply getting in touch when you need us. More information is available in the accessories and services chapter.	
BINDER INDIVIDUAL	Using a BINDER series production product as a basis, we develop individual solutions as a single unit or in small batches. All products are tested, certified, and supplied with a full functional guarantee and warranty. More information is available in the accessories and services chapter.	

► All extras online go2binder.com/en-options

TECHNICAL DATA

Description	VD 23	VD 56	VD 115
Measures			
Interior volume [L]	24	55	119
Net weight of the unit (empty) [kg]	68	101	146
Permitted load [kg]	50	60	70
Load per rack [kg]	20	20	20
Wall clearance back [mm]	100	100	100
Wall clearance sidewise [mm]	70	70	70
Internal Dimensions			
Width [mm]	285	400	506
Height [mm]	285	400	506
Depth [mm]	295	343	460
Housing dimensions not incl. fittings and connections			
Width net [mm]	523	638	743
Height net [mm]	698	815	942
Depth net [mm]	413	461	581
Performance Data Temperature			
Temperature range +9 °C above ambient temperature to [°C]	220	220	220
Temperature variation at 100 °C [± K]	1.0	1.5	2.9
Temperature fluctuation [± K]	0.1	0.1	0.1
Heating-up time to 100 °C [min]	80	80	130
Electrical data			
Nominal power (version 120 V) [kW]	0.9	1.4	1.6
Nominal power (version 230 V) [kW]	0.9	1.4	1.6
Fixtures			
Number of shelves (std./max.)	1/4	1/5	1/6

ORDERING INFORMATION [Art. No.]

Further details: Go to www.binder-world.com > Search > Enter Article Number

Voltage	Option model	VD 23	VD 56	VD 115
200...230 V 1~ 50/60 Hz	Standard	9630-0001	9630-0002	9630-0003
100...120 V 1~ 50/60 Hz	Standard	9630-0005	9630-0006	9630-0007

DIMENSIONS incl. fittings and connections [mm]

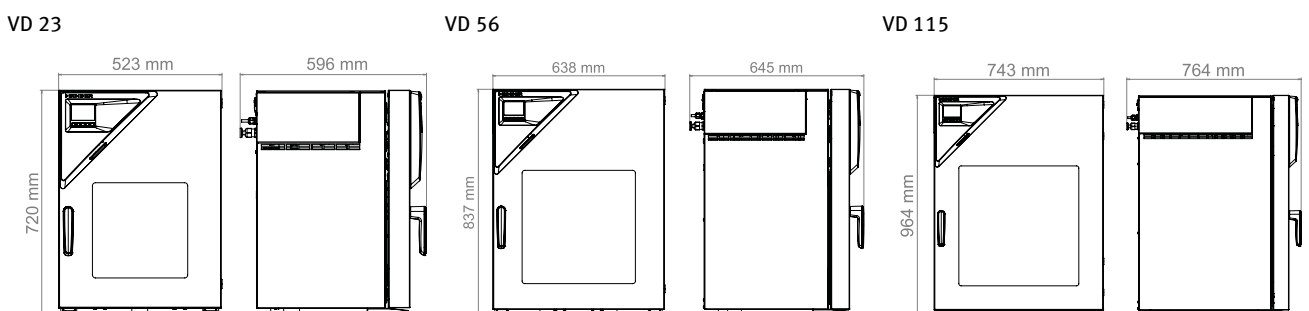

ORDERING INFORMATION OPTIONS

Bezeichnung	Beschreibung	VD 23	VD 56	VD 115	Art.-Nr.
Additional universal ventilation	Additional universal connection for ventilation with ambient air or inert gas. Flow limiter thread (RP"), and connection with 3/8" male thread.	•	•	•	8612-0001
Analog output 4-20 mA	for temperature and pressure values (output not adjustable)	•	•	•	8612-0004
Calibration certificate, expanded	for temperature; for extending the measurement in center of chamber to include another test temperature	•	•	•	8012-1127
Calibration certificate, pressure	for digital pressure display, measurement at 100 mbar or at specified pressure (range 20 – 900 mbar)	•	•	•	8012-0440
Calibration certificate, temperature	for temperature, measurement in center of chamber at specified temperature	•	•	•	8012-1145
	temperature measurement incl. certificate, 15- 18 measuring points at specified temperature	•	•	•	8012-0919
	temperature measurement incl. certificate, 9 measuring points at specified temperature	•	•	•	8012-0916
Door gasket	made of FKM, silicone-free	•	–	–	8612-0007
		–	•	–	8612-0008
		–	–	•	8612-0009
Door lock	lockable door handle	•	•	•	8612-0002
Expansion racks	stainless steel expansion rack instead of standard aluminum expansion rack, incl. calibration	•	–	–	8612-0011
		–	•	–	8612-0012
		–	–	•	8612-0013
Interior lighting	LED light strips on the left and right in the door	•	•	•	8612-0005
Temperature measurement of the specimen	with flexible Pt 100 sensor and digital specimen temperature display	•	•	•	8612-0006
Touchscreen controller	Large display with intuitive operation; actual and set values of key process parameters are shown on the display at the same time. It is also possible to perform graphical time-based evaluation of process parameters.	•	•	•	8612-0015
Universal access port	Additional DN 40 small flange universal access port with blind flange, for positioning sensors or supply lines in the chamber.	•	•	•	8612-0003

ORDERING INFORMATION ACCESSORIES

Bezeichnung	Beschreibung	VD 23	VD 56	VD 115	Art.-Nr.
APT-COM™ 4 BASIC-Edition	for simple logging and documentation requirements with up to 5 networked units. version 4, BASIC edition	•	•	•	9053-0039
APT-COM™ 4 GLP-Edition	for working under GLP-compliant conditions. Measured values are documented in a tamper-proof way in line with the requirements of FDA Regulation 21 CFR 11. version 4, GLP edition	•	•	•	9053-0042
APT-COM™ 4 PROFESSIONAL-Edition	convenient unit and user management built on the BASIC edition. Suitable for networking up to 100 units. version 4, PROFESSIONAL edition	•	•	•	9053-0040
Expansion racks	stainless steel	•	–	–	8009-1093
		–	•	–	8009-1092
		–	–	•	8009-1091
		•	–	–	8009-1031
		–	•	–	8009-1030
pH-neutral detergent	concentrated, for gentle remove of residual contaminants; 1 kg	–	–	•	8009-1029
		•	•	•	1002-0016

Bezeichnung	Beschreibung	VD 23	VD 56	VD 115	Art.-Nr.
Qualification documents	IQ/OQ documents – supporting documents for validation performed by customers, consisting of: IQ/OQ checklists incl. calibration guide and comprehensive unit documentation; parameters: temperature, CO ₂ , O ₂ , pressure, depending on unit				
	Digital in PDF format	•	•	•	7057-0001
	Hard copy inside folder	•	•	•	7007-0001
	IQ/OQ/PQ documents – supporting documents for validation performed by customers, according to customer requirements, PQ section added to qualification folder IQ/OQ; parameters: temperature, CO ₂ , O ₂ – or pressure, depending on unit				
	Digital in PDF format	•	•	•	7057-0005
	Hard copy inside folder	•	•	•	7007-0005
Vacuum module with vacuum pump VAP 1	Pump chamber for vacuum pumps, with switchable power socket. Chemical membrane pump with a nominal air flow of 2.0 m ³ /hour, final pressure 7 mbar, including all necessary parts for vacuum connection				
	120 V / 50-60 Hz option model	•	–	–	8012-1961
		–	•	–	8012-1962
		–	–	•	8012-1963
		•	–	–	8012-1958
	230 V / 50-60 Hz option model	–	•	–	8012-1959
	–	–	•	8012-1960	
Vacuum module with vacuum pump VAP 2	Pump chamber for vacuum pumps, with switchable power socket. Chemical membrane pump with a nominal air flow of 4.0 m ³ /hour, final pressure 1,8 mbar, including all necessary parts for vacuum connection				
	120 V / 50–60 Hz option model	•	–	–	8012-1967
		–	•	–	8012-1968
		–	–	•	8012-1969
		•	–	–	8012-1964
	230 V / 50-60 Hz option model	–	•	–	8012-1965
	–	–	•	8012-1966	
Vacuum pump connection kit	for vacuum pump VAP1 and VAP2; consisting of aluminum clamping ring, universal centering ring, small flange with hose nozzle, (2.5 m) rubber hose and 2 hose clamps	•	•	•	8012-1995
Vacuum pump VAP 1	Chemical membrane pump with a nominal air flow of 2.0 m ³ /hour, final pressure 7 mbar, including all necessary parts for vacuum connection				
	120 V / 50-60 Hz option model	•	•	•	5013-0223
	230 V / 50-60 Hz option model	•	•	•	5013-0217
Vacuum pump VAP 2	Chemical membrane pump with a nominal air flow of 4.0 m ³ /hour, final pressure 1,8 mbar, including all necessary parts for vacuum connection				
	120 V / 50-60 Hz option model	•	•	•	5013-0219
	230 V / 50-60 Hz option model	•	•	•	5013-0218

Series VDL | for flammable solvents

BINDER VDL series safety vacuum drying chambers ensure maximum safety when drying organic solvents. Explosion-protected unit with classification according to ATEX directive 2014/34/EU: EX II 2/3/- G IIB T3 Gb/Gc/- X.

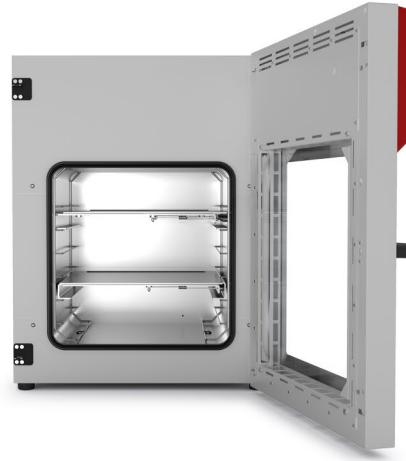

VDL 115 model

BENEFITS

- Fast, gentle drying
- Optimum heat transfer through large thermal conducting plates
- Safe working thanks to ATEX-compliant safety concept
- Also option of modular complete system with vacuum pump and pump chamber

MAIN FEATURES

- Temperature range: Ambient temperature +9 °C to +110 °C
- ATEX conformity for units: EX II 2/3/- G IIB T3 Gb/Gc/- X
- Intuitive touchscreen controller with graphical pressure and temperature display
- Program-controlled drying monitoring with automatic ventilation at end of process
- Internal data logger, measured values can be read out in open format via USB
- Pressure control device for heating activated from < 100 mbar
- 2 aluminum expansion racks, can be custom-positioned
- Universal connection for ventilation with ambient air or inert gas
- DN 16 universal access port with small flange and blind flange, for positioning sensors or supply lines in the chamber
- Shatterproof, spring-mounted safety glass panel

AVAILABLE SIZES

Model	Interior volume [L]	Online data sheets
VDL 23	24	› go2binder.com/en-VDL23
VDL 56	55	› go2binder.com/en-VDL56
VDL 115	119	› go2binder.com/en-VDL115



TIPS & TRICKS





Benefit from our many years of experience, as demonstrated in our technical papers:

Tips & Tricks: › go2binder.com/en-tips-tricks
 Case Studies: › go2binder.com/en-case-studies

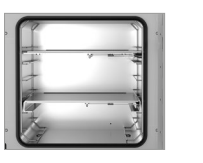

Find all details online: go2binder.com/en-VDL

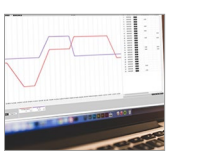
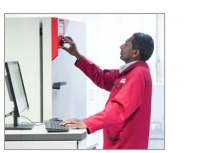
OPTIONAL EQUIPMENT

<p>Expansion racks</p>	<p>The expansion racks ensure maximum heat transfer to the items to be dried. You can choose between aluminum and stainless steel racks.</p>	
<p>Analogue output for temperature and pressure</p>	<p>For external monitoring and evaluation of process parameters, option of integration into on-site systems.</p>	
<p>Universal ventilation</p>	<p>For the convenient selection of different ventilation types, with air or inert gas. The valves can be actuated in a targeted manner via the controller or the APT-COM Multi Management Software.</p>	
<p>Universal access port DN 40</p>	<p>For inserting and positioning sensors or supply lines in the vacuum chamber.</p>	
<p>Pump module with vacuum pump</p>	<p>The pump module lifts your vacuum oven to the optimum working height, it also significantly reduces the noise of the vacuum pump and protects the pump and glass material from mechanical damage. The pump in the module can be switched on and off using a switchable socket via the control of the vacuum furnace.</p>	
<p>Vacuum pumps</p>	<p>Our range of membrane pumps, chemistry membrane pumps, or speed-controlled chemistry membrane pumps is perfectly matched to the BINDER vacuum chambers in question. When connected to the pump chamber, the vacuum pump and flask are protected against mechanical damage.</p>	
<p>Multi Management Software APT-COM</p>	<p>Software for managing, recording and documenting device parameters is available in three versions: Basic, Professional and GLP.</p>	
<p>Services</p>	<p>You can access our installation, maintenance, calibration, validation, or warranty services by taking out a Maintenance Service Agreement or by simply getting in touch when you need us. More information is available in the accessories and services chapter.</p>	
<p>BINDER INDIVIDUAL</p>	<p>Using a BINDER series production product as a basis, we develop individual solutions as a single unit or in small batches. All products are tested, certified, and supplied with a full functional guarantee and warranty. More information is available in the accessories and services chapter.</p>	

► All extras online go2binder.com/en-options

TECHNICAL DATA

Description	VDL 23	VDL 56	VDL 115
Measures			
Interior volume [L]	24	55	119
Net weight of the unit (empty) [kg]	72	104	158
Permitted load [kg]	50	60	70
Load per rack [kg]	20	20	20
Wall clearance back [mm]	100	100	100
Wall clearance sidewise [mm]	70	70	70
Internal Dimensions			
Width [mm]	285	400	506
Height [mm]	285	400	506
Depth [mm]	295	343	460
Housing dimensions not incl. fittings and connections			
Width net [mm]	523	638	743
Height net [mm]	698	815	942
Depth net [mm]	413	461	581
Performance Data Temperature			
Temperature range +9 °C above ambient temperature to [°C]	110	110	110
Temperature variation at 100 °C [± K]	1.0	1.5	2.9
Temperature fluctuation [± K]	0.1	0.1	0.1
Heating-up time to 100 °C [min]	150	140	170
Electrical data			
Nominal power (version 120 V) [kW]	0.9	1.4	1.6
Nominal power (version 230 V) [kW]	0.9	1.4	1.6
Fixtures			
Number of shelves (std./max.)	2/4	2/5	2/6

ORDERING INFORMATION [Art. No.]

Further details: Go to www.binder-world.com > Search > Enter Article Number

Voltage	Option model	VDL 23	VDL 56	VDL 115
200...230 V 1~ 50/60 Hz	Standard	9630-0009	9630-0010	9630-0011
100...120 V 1~ 50/60 Hz	Standard	9630-0013	-	9630-0015
100...230 V 1~ 50/60 Hz	Standard	-	9630-0014	-

DIMENSIONS incl. fittings and connections [mm]

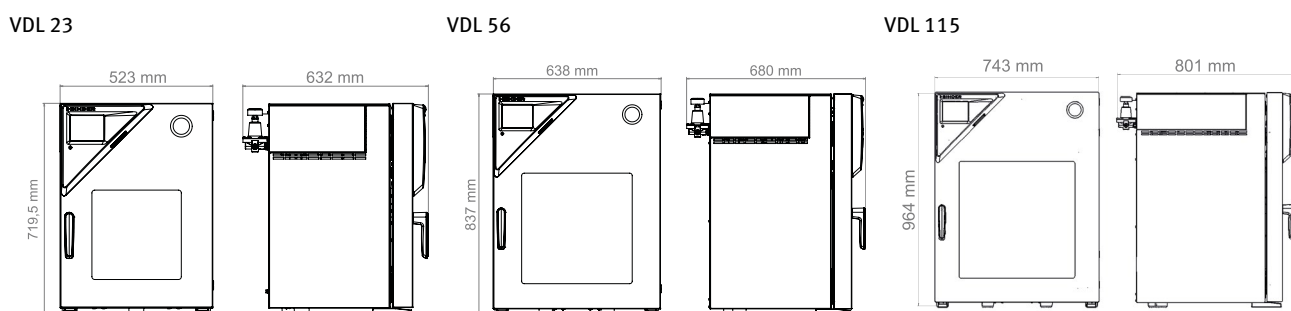

ORDERING INFORMATION OPTIONS

Bezeichnung	Beschreibung	VDL 23	VDL 56	VDL 115	Art.-Nr.
Additional universal ventilation	Additional universal connection for ventilation with ambient air or inert gas. Flow limiter thread (RP"), and connection with 3/8" male thread.	•	•	•	8612-0001
Analog output 4-20 mA	for temperature and pressure values (output not adjustable)	•	•	•	8612-0004
Calibration certificate, expanded	for temperature; for extending the measurement in center of chamber to include another test temperature	•	•	•	8012-1127
Calibration certificate, pressure	for digital pressure display, measurement at 100 mbar or at specified pressure (range 20 – 900 mbar)	•	•	•	8012-0440
Calibration certificate, temperature	for temperature, measurement in center of chamber at specified temperature	•	•	•	8012-1145
	temperature measurement incl. certificate, 15- 18 measuring points at specified temperature	•	•	•	8012-0919
	temperature measurement incl. certificate, 9 measuring points at specified temperature	•	•	•	8012-0916
Door gasket	made of FKM, silicone-free	•	–	–	8612-0007
		–	•	–	8612-0008
		–	–	•	8612-0009
Door lock	lockable door handle	•	•	•	8612-0002
Expansion racks	stainless steel expansion rack instead of standard aluminum expansion rack, incl. calibration	•	–	–	8612-0011
		–	•	–	8612-0012
		–	–	•	8612-0013
Temperature measurement of the specimen	with flexible Pt 100 sensor and digital specimen temperature display	•	•	•	8612-0006
Universal access port	Additional DN 40 small flange universal access port with blind flange, for positioning sensors or supply lines in the chamber.	•	•	•	8612-0003

ORDERING INFORMATION ACCESSORIES

Bezeichnung	Beschreibung	VDL 23	VDL 56	VDL 115	Art.-Nr.
APT-COM™ 4 BASIC-Edition	for simple logging and documentation requirements with up to 5 networked units. version 4, BASIC edition	•	•	•	9053-0039
APT-COM™ 4 GLP-Edition	for working under GLP-compliant conditions. Measured values are documented in a tamper-proof way in line with the requirements of FDA Regulation 21 CFR 11. version 4, GLP edition	•	•	•	9053-0042
APT-COM™ 4 PROFESSIONAL-Edition	convenient unit and user management built on the BASIC edition. Suitable for networking up to 100 units. version 4, PROFESSIONAL edition	•	•	•	9053-0040
Expansion racks	stainless steel	•	–	–	8009-1093
		–	•	–	8009-1092
		–	–	•	8009-1091
	aluminum	•	–	–	8009-1031
		–	•	–	8009-1030
		–	–	•	8009-1029
pH-neutral detergent	concentrated, for gentle remove of residual contaminants; 1 kg	•	•	•	1002-0016

Bezeichnung	Beschreibung	VDL 23	VDL 56	VDL 115	Art.-Nr.
Qualification documents	IQ/OQ documents – supporting documents for validation performed by customers, consisting of: IQ/OQ checklists incl. calibration guide and comprehensive unit documentation; parameters: temperature, CO ₂ , O ₂ , pressure, depending on unit				
	Digital in PDF format	•	•	•	7057-0001
	Hard copy inside folder	•	•	•	7007-0001
	IQ/OQ/PQ documents – supporting documents for validation performed by customers, according to customer requirements, PQ section added to qualification folder IQ/OQ; parameters: temperature, CO ₂ , O ₂ – or pressure, depending on unit				
	Digital in PDF format	•	•	•	7057-0005
	Hard copy inside folder	•	•	•	7007-0005
Vacuum module with vacuum pump VP 4	Chemical membrane pump with nominal pumping speed 1.9 m ³ /h, final pressure 12 mbar, with separator and emission condenser, ATEX conformity: suction chamber (pumped gases): II 2G IIC T3 X, exterior with inert-gas flushing: II 2G IIB T4 X, exterior without inert-gas flushing: II 3G IIB T4 X, motor: II 2G Ex d IIB T4 Gb, including all necessary parts for vacuum connection	•	–	–	8012-1970
	230 V / 50 Hz option model	–	•	–	8012-1971
		–	–	•	8012-1972
		•	•	•	8012-0621
Vacuum pump connection kit (ATEX)	for vacuum pump VP 4; consisting of clamping rings, universal centering rings, transition piece, anti-static vacuum hose, union nut, and elbow	•	•	•	8012-0621
Vacuum pump VP 4	Chemical membrane pump with nominal pumping speed 1.9 m ³ /h, final pressure 12 mbar, with separator and emission condenser, ATEX conformity: Suction chamber (pumped gases): II 2G IIC T3 X, exterior with inert-gas flushing: II 2G IIB T4 X, exterior without inert-gas flushing: II 3G IIB T4 X, motor: II 2G Ex d IIB T4 Gb				
	230 V / 50 Hz option model	•	•	•	5013-0049

BINDER products

CO₂ incubators

Incubators

Cooling incubators

Growth chambers

Ultralow temperature freezers

Drying and heating chambers

Safety drying chambers

Vacuum drying chambers

Constant climate chambers

Dynamic climate chambers

Battery test chambers

Multi Management Software



Never miss a product novelty -
Subscribe and keep up to speed with
the BINDER monthly newsletter.

Subscription

go2binder.com/en-newsletter-subscription

BINDER

Best conditions for your success

BINDER GmbH

Tuttlingen, Germany

Tel +49 7462 2005 0
Fax +49 7462 2005 100
info@binder-world.com
www.binder-world.com

BINDER Asia Pacific (Hong Kong) Ltd.

Kowloon, Hong Kong, P.R. China

Tel +852 39070500
Fax +852 39070507
asia@binder-world.com

BINDER Environmental Testing Equipment (Shanghai) Co., Ltd.

Shanghai, P.R.China

Tel +86 21 685 808 25
Fax +86 21 685 808 29
china@binder-world.com

Representative Office for CIS

Moscow, Russia

Tel +7 495 988 15 16
Fax +7 495 988 15 17
russia@binder-world.com

BINDER Inc.

Bohemia, NY, USA

Tel +1 631 224 4340
Fax +1 631 224 4354
usa@binder-world.com