

Hochgenauigkeits-Extensometer

für universelle und spezielle Anwendungen in der Werkstoffprüfung

High Precision-Extensometers

for universal and special applications in material testing



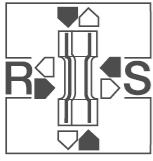

Why should you decide on a SANDNER Extensometer?

Because, SANDNER products

- are of very high measuring accuracy
- have been developed over long years.
- have proven their worth worldwide.
- are of modular design permitting extension at any time.
- have a very high specification.
- are available in a variety of special versions in addition to the standard designs described herein.
- have a very attractive price/performance ratio.
- are available on short call.

Why does materials testing make increasingly high demands on measuring an control accuracies?

There are a whole number of reasons, among them the fact that modern fundamental materials research, optimization, and quality control can not meet their objectives without refined measuring methods.

For material properties and associated influential variables to be accurately determined, various methods often require to be combined.

Extensometers are indispensable here, ensuring direct measurement on material specimens for the control of strain and crack depth within a preselected range.

Measurement results serve to determine fundamental physical characteristics, such as Young's modulus, COD-value, J-integral, poisson's ration, crack toughness, yield point, R-curve, rate of crack mouth opening, etc.

To meet the requirement of practice-oriented simulation in materials tests, the characteristics above are ascertained with test parameters combined as required for the particular application.

Extensometers are attached directly to the specimen. Thus they must be capable of meeting the very highly differing test conditions to which the specimen itself is exposed. The most essential test conditions, which may occur in any random combination, demonstrate that an Extensometer must have a number of positive properties.

Test conditions for Extensometers

- Static and dynamic operation.
- Measuring axes: axial, diametral, biaxial, triaxial, torsional, internal, external.
- Very high and low temperatures.
- High and low humidity
- Liquid and gaseous media.
- Chemically neutral or aggressive media.
- High-pressure and vacuum atmospheres.
- UV, IR, gamma and radioactive radiation.

SANDNER Extensometers selected for the respective application ensure best measurement results. Name the problem, and we will help you choose suitable Extensometers.

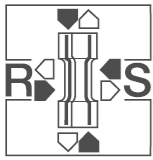

Cover photo shows SANDNER EXTENSOMETERS for the simultaneous measurement of axial and diametral changes in a round specimen.

EXA 50-5
Axial EXTENSOMETER with gauge length extender.

EXD 15-0,5
Diametral EXTENSOMETER

Picture shows a selection of SANDNER EXTENSOMETERS for use on different types of specimens.

① **EXD 15-0,5**
Diametral EXTENSOMETER for measuring diametrel change in round specimens.

② **EXA 25-0,625**
Axial EXTENSOMETER for measuring change in length in flat specimens.

③ **EXR 10-0,5**
Crack growth EXTENSOMETER for CT-specimens or for determining J-integral.

④ **EXA 10-0,5**
Axial EXTENSOMETER for measuring changes in length in round specimens.

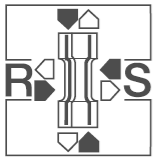

SANDNER Extensometers have for many years proven their excellent reliability in materials testing – even when used under severe conditions.

Our ever-increasing international clientel is a measure of quality and technical superiority of our EXTENSOMETERS.

SANDNER Extensometers operate on the well proven bending beam measuring principle and use modern, suitable materials. Then bending beam is a measuring spring to which are applied 350Ω strain gauges connected so as to form a wheatstone bridge and which is protected from damage by a cover hood. Extensometers are fitted with a special 500 mm long cable with a size 304 lemosa plug. The measuring signal is available across contacts 1 & 4, and the supplz voltage of max. 10V DC or AC is applied across contacts 2 & 3. A thermal stabilisation time of approx. 10 min. should be allowed before measurements commence. The digital display indicates a +sign for tension and a –sign for compression.

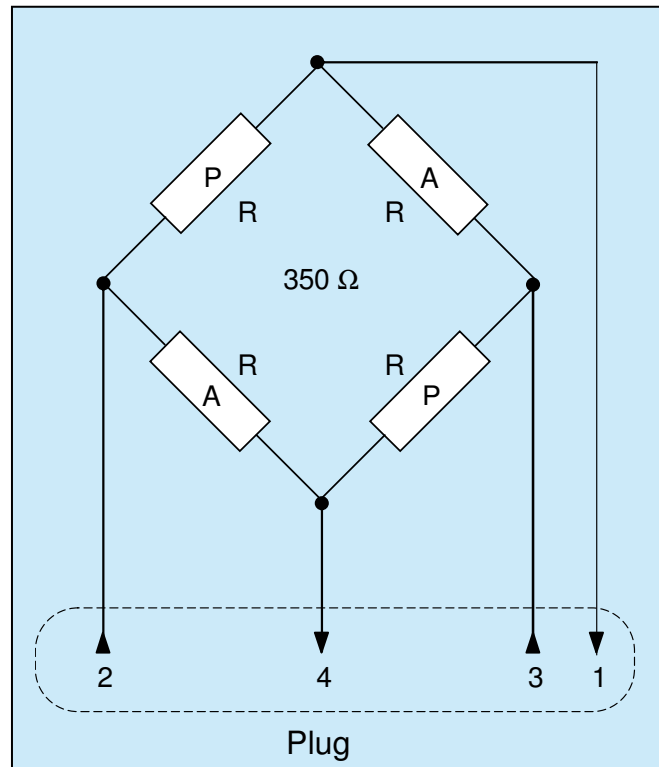

The warranty period for SANDNER Extensometers is 12 months for manufacturing and material defects, in accordance with our “General terms of delivery”, except for parts subject to wear such as knife edges and ceramic rods, which carry a 30 day warranty

Selection table for SANDNER standard Extensometers.
Special disigns are available on request.

Test	Recommended Model	Spec. Page No.
<ul style="list-style-type: none"> ● Tension/Compression DIN/AST/E8 Young`s modulus Elastic limit Poisson`s ratio Creep 	<p>EXA + gauge length extenders</p> <p>EXA 10-0,25 or 0,5</p> <p>EXA / EXD</p>	<p>7 - 8 - 15 - 16</p> <p>7 - 8</p> <p>7 - 8 - 11- 12</p>
<ul style="list-style-type: none"> ● Fatigue Low Cycle DIN ASTM E 606 High cycle Crack growth 	<p>EXA + gauge length extenders</p> <p>High-temperature version</p> <p>EXA 10-0,25 or 0,5</p> <p>EXR</p>	<p>7 - 8 - 13 - 14</p> <p>15 - 16</p> <p>7 - 8 - 15 - 16</p> <p>9 - 10</p>
<ul style="list-style-type: none"> ● Bending Displacement Crack growth 	<p>EXA + gauge length extenders</p> <p>EXR</p>	<p>7 - 18 15 - 16</p> <p>9 - 10</p>
<ul style="list-style-type: none"> ● Fracture mechanics K_{ic} (DIN, ASTM E 399) J-Integral 	<p>EXR</p> <p>EXR</p>	<p>9 - 10</p> <p>9 - 10</p>

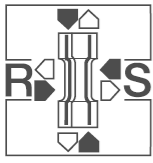

Series EXA, EXR, EXH over 400 types are available. On special order, customer-related EXTENSOMETERS will be developed and manufactured.

SANDNER-Extensometers are of universal use and can be operated in conjunction with almost any type of testing machine.

They allow a carrier frequency or DC amplifiers to be connected with a supply voltage output of up to 10V.

A convenient 4 ½ digit measuring amplifier is available.

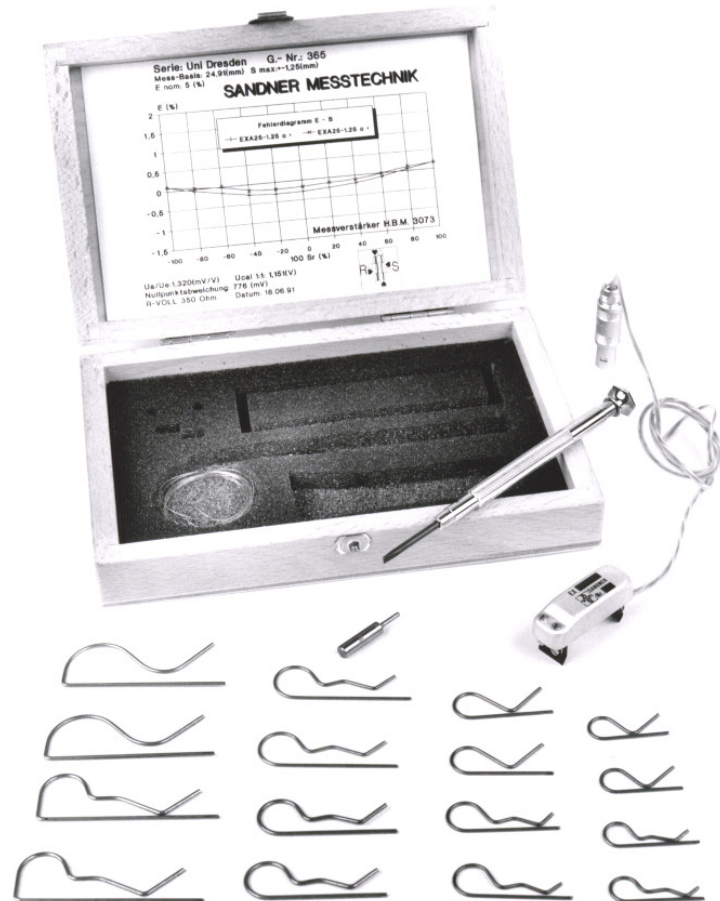

Figure to the right shows scope of delivery of an axial Extensometer EXA 25-0625

EXA Extensometers are delivered in a storage case, complete with attachment springs for round and flat specimens of 1-18 mm, and a diagram giving hysteresis, nonlinearity and sensitivity.

Depending on the model supplied with it is a gauge block or locking pin for fixing the appropriate gauge length as EXTENSOMETER is attached to the specimen.

Mechanical stops are fitted to protect the EXTENSOMETER in case of specimen breaks plus means to prevent it from dropping.

Suitable tools for replacement of worn parts or conversion of an axial EXTENSOMETER to a D or R version are supplied.

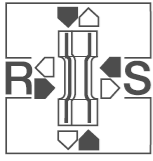

Main technical data of Extensometers

Four different basic EXTENSOMETER units are available:

1. Basic unit No.1: Gauge length 5-15 mm
2. Basic unit No.2: Gauge length 20-30 mm
These basic units combine very small size with high a large measurement range
3. Basic unit No.3: Gauge length 5-15 mm.
This particular base unit combines very small size with high sensitivity (measurement range $\pm 0,25\text{mm}$)
4. Basic unit No.4: Gauge length 20-30.mm (measurement range $\pm 0,625\text{mm}$)

Basic units No.3 & 4 are characterised by a very high frequency (500 Hz).
They enable test frequencies up to 0,3 times the natural frequency to be realized.

Extensometers No. 3 & 4 are new developments characterised by very small nonlinearity and hysteresis error.

All of these Extensometers can be operated in electrically nonconducting liquids, such as alcohol, silicone or acetone.

The sensitivity of these EXTENSOMETERS is in the range of $1,6 \text{ mV/V} \pm 25\%$.
The exact caliber is given in the specific Extensometer diagram in combination with the delivery.

Weight: 5 to 100 g, depending on model.

Natural frequency: max. 500 Hz

Operating temperature: -270°C bis $+1200^\circ\text{C}$, depending on model.

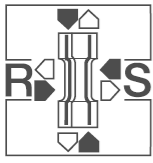

Series EXA Axial EXTENSOMETERS

Picture 1 shows a high-accuracy type EXA 10-0,25 axial Extensometer applied to a round specimen of 8 mm diameter.

This EXTENSOMETER specially was developed for testing new materials, such as carbon fibres, ceramics, etc., as well as for determining the properties of organic materials.

It is characterised by very low weight, high natural frequency, and a high accuracy of $\pm 0,1\%$ of full scale. Gauge length is 10 mm; measuring range $\pm 0,25$ mm.

It will even allow dynamic endurance strength tests on very small specimens to be performed without any problem.

Provided springs will ensure quick and safe attachment to the specimen.

The standard 60° knife edges can be replaced when worn in a matter of minutes

Upon special request, knife edges are available with different angles and supports and/or in other materials.

Included in the scope of delivery for EXA Extensometers are:

- Extensometer in storage case with 500 mm cable and lamosa plug.
- Attachment springs for round and flat specimens of 1-18 mm
- Screw driver
- Nylon string
- Interlocking pin or gauge block
- Data sheet giving all extensometer-specific data, as regards hysteresis, measurement error, and sensitivity.

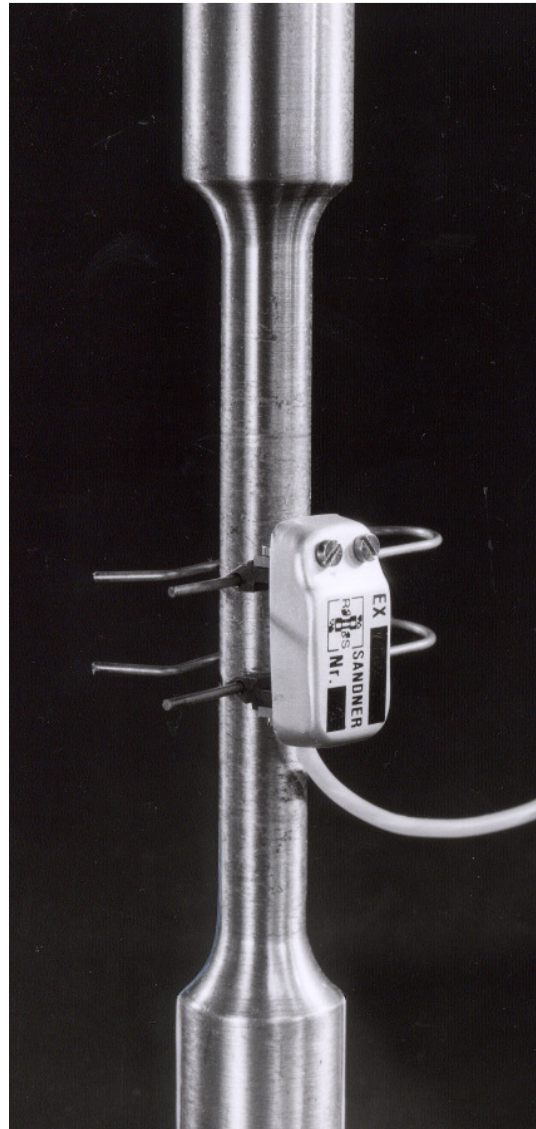

Pic.1

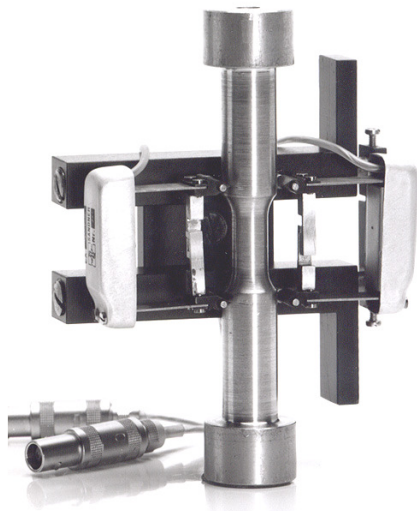

Pic.2 shows an double.Extensometer in a special version on customers request, with 25 mm measuring basis and $\pm 2,5$ mm measuring range.

Double Extensometers are available from 25 mm measuring basis.

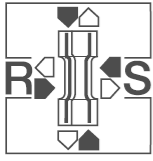

Ordering example:

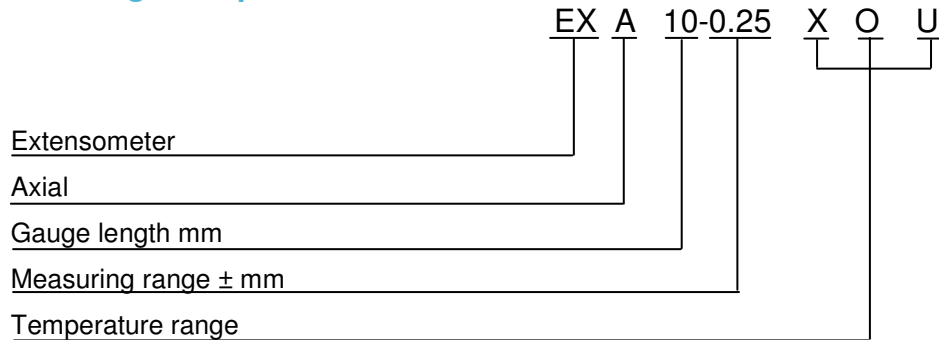

X = - 80 °C - +120 °C
O = -270 °C - +220 °C
U = -270 °C - +300 °C (momentary)

Model Typr	Gauge Length [mm]	Measuring Displacement [mm]	Measuring error of full scale [± %]	Natural frequency [Hz]	Activation force [N]	Weight [g]	Dimensions		
							L [mm]	B [mm]	H [mm]
EXA 10-0,25	10	± 0,25	0,1	500	3	5	20	10	15
EXA 10-0,5	10	± 0,5	0,3	500	3	5	20	10	15
EXA 10-1	10	± 1	0,25	250	3	6	20	10	21
EXA 10-2	10	± 2	0,25	100	3	7	20	10	29
EXA 10-5	10	± 5	0,3	40	0,7	12	20	10	65
EXA 15-0,5	15	± 0,5	0,25	500	3	5	20	10	20
EXA 15-1	15	± 1	0,3	250	3	5	20	10	20
EXA 15-2	15	± 2	0,3	100	3	6	20	10	32
EXA 15-4	15	± 4	0,3	40	0,7	12	20	10	65
EXA 20-0,625	20	± 0,625	0,2	500	3	7	34	10	25
EXA 20-1,25	20	± 1,25	0,35	500	3	7	34	10	25
EXA 20-1,250	20	± 1,25	0,2	500	3	8	34	10	31
EXA 20-2,5	20	± 2,5	0,35	250	3	8	34	10	31
EXA 20-5	20	± 5	0,35	100	3	9	34	10	45
EXA 20-10	20	± 10	0,35	40	0,7	14	34	10	68
EXA 25-0,625	25	± 0,625	0,1	500	3	7	34	10	25
EXA 25-1,25	25	± 1,25	0,2	500	3	7	34	10	25
EXA 25-1,250	25	± 1,25	0,1	500	3	8	34	10	31
EXA 25-2,5	25	± 2,5	0,2	250	3	8	34	10	31
EXA 25-5	25	± 5	0,2	100	3	9	34	10	45
EXA 25-10	25	± 10	0,3	40	0,7	14	34	10	65
EXA 30-0,625	30	± 0,625	0,2	500	3	7	34	10	25
EXA 30-1,25	30	± 1,25	0,35	500	3	7	34	10	25
EXA 30-1,250	30	± 1,25	0,2	500	3	8	34	10	31
EXA 30-2,5	30	± 2,5	0,35	250	3	8	34	10	31
EXA 30-5	30	± 5	0,35	100	3	9	34	10	45
EXA 30-10	30	± 10	0,35	40	0,7	14	34	10	65
EXA 40-4	40	± 4	0,2	250	2,5	22	44	10	40
EXA 50-5	50	± 5	0,2	250	2,5	24	54	10	46
EXA 60-6	60	± 6	0,2	250	2,5	28	64	10	53
EXA 70-7	70	± 7	0,2	250	2,5	31	74	10	60
EXA 80-8	80	± 8	0,2	250	2,5	33	84	10	68
EXA 90-9	90	± 9	0,2	250	2,5	36	94	10	76
EXA 100-10	100	± 10	0,2	250	2,5	38	105	10	82

All measuring errors include hysteresis and nonlinearity related to full scale.

Alternating loads are able to increase measuring errors.

Subject to modifications.

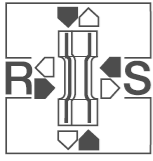

Series EXR crack mouth opening Extensometers

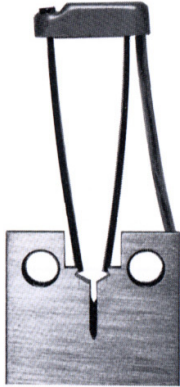

The left photo shows a clip-on Extensometer attached to a CT (compact tension) specimen for measurements in the load line. It is perfect for J-integral tests with large gauge length and range of measuring displacement. Adjustment to the specimen is simple but accurate. The EXTENSOMETER is available for gauge length from 2mm up to 5mm (depressed position) and can be clipped on either to knife edges screwed to the specimen or to mounted specimen edges, as shown on the photo.

Other clip-on Extensometers with non standard values are available upon request.

The right photo shows EXR 10-05 crack mouth opening Extensometer applied to compact tensile force (CT) specimen. This Extensometer is a combination between EXA 10-0,5 axial Extensometer with a pair of knife edges according to ASTM E-399 standard and spread spring attaching Extensometer. Crack mouth opening values are assigned via calibration curve, crack length values used to determine material characteristics δ_C , R-Kurve, J_{IC} and K_{IC} .

EXR EXTENSOMETERS are suitable for tensile, bending, and fracture mechanical tests on specimens, original component parts and assemblies of any profiling.

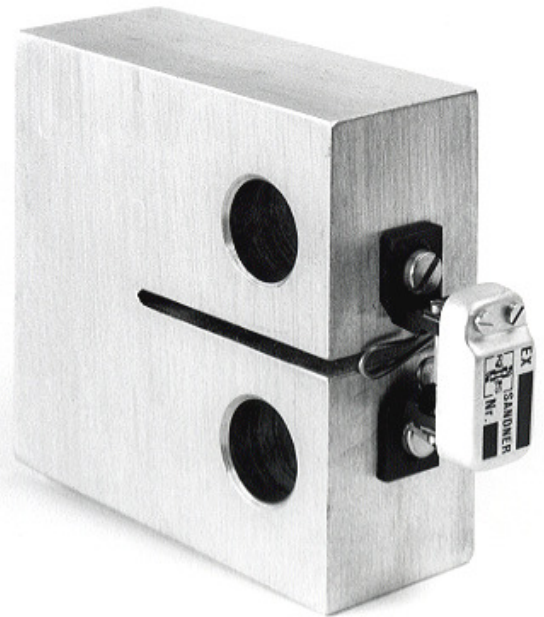

The EXR Extensometer is supplied as:

- Extensometer in storage case with 500 mm cable and lemosa plug.
- ASTM norm knife edges and pivots
- Press-on spring
- Nylon string
- Screw driver
- Data sheet giving all extensometer-specific data in respect to hysteresis, measuring error and sensivity.

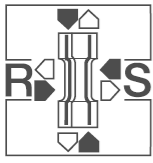

Ordering example:

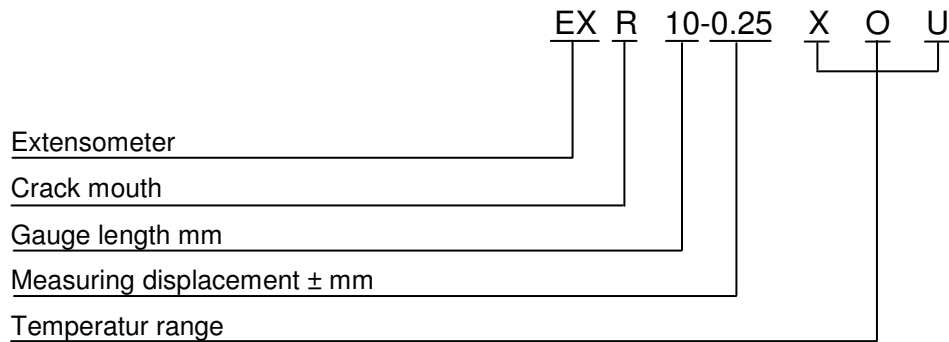

X = -80 °C - +120 °C
 O = -270 °C - +220 °C
 U = -270 °C - +300 °C (momentary)

Model type x/o/u Version	Gauge length [mm]	Measuring displacement [mm]	Measuring error of full scale [± %]	Natural frequency [Hz]	Weight [g]	Dimensions		
						L [mm]	B [mm]	H [mm]
EXR 10-0,25	10	± 0,25	0,15	500	3 - 8	20	10	17
EXR 10-0,5	10	± 0,5	0,25	500	3 - 8	20	10	17
EXR 10-1	10	± 1	0,25	250	3 - 8	20	10	23
EXR 10-2	10	± 2	0,25	100	3 - 8	20	10	31
EXR 10-5	10	± 5	0,35	40	3 - 8	20	10	67
EXR 20-0,625	20	± 0,625	0,25	500	3 - 8	34	10	25
EXR 20-1,25	20	± 1,25	0,25	500	3 - 8	34	10	25
EXR 20-2,5	20	± 2,5	0,25	250	3 - 8	34	10	31
EXR 20-5	20	± 5	0,25	100	3 - 8	34	10	45
EXR 20-10	20	± 10	0,35	40	3 - 8	34	10	65
EXR 25-0,625	25	± 0,625	0,15	500	3 - 8	34	10	25
EXR 25-1,25	25	± 1,25	0,25	500	3 - 8	34	10	25
EXR 25-2,5	25	± 2,5	0,25	250	3 - 8	34	10	31
EXR 25-5	25	± 5	0,25	100	3 - 8	34	10	45
EXR 25-10	25	± 10	0,35	40	3 - 8	34	10	65
EXR 30-0,625	30	± 0,625	0,3	500	3 - 8	34	10	25
EXR 30-1,25	30	± 1,25	0,3	500	3 - 8	34	10	25
EXR 30-2,5	30	± 2,5	0,3	250	3 - 8	34	10	31
EXR 30-5	30	± 5	0,3	100	3 - 8	34	10	45
EXR 30-10	30	± 10	0,35	40	3 - 8	34	10	65
Clip-on								
		alternativ						
EXRC 2	2	+ 3, +4, +5, +6	0,1	80	8	20	10	67
EXRC 3	3	+ 3, +4, +5, +6	0,1	80	8	20	10	67
EXRC 4	4	- 3, ±3, +4, +5, +6	0,1	80	8	20	10	67
EXRC 5	5	- 3,5, ±3, +4, +5, +6	0,1	80	8	20	10	67

All measuring errors include hysteresis and nonlinearity related to full scale.
 Alternating loads are able to increase measuring errors. Subject to modifications.

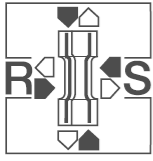

Series EXD diametral Extensometers

All diametral Extensometers from our range can be used to determine circumferential length changes in flat or round specimens, in tensile or compression tests, and under static or dynamic load. The maximum permissible test frequency is given in the data sheet on the backside. The Extensometers are matched with the aid of two adjusting screws to the respective specimen thickness, so that one Extensometer can be used to cover a wide spectrum of specimen diameters.

Another advantage of our diametral Extensometers is that they can be applied direct to the specimen without the use of aids. This ensures that deformations in the area of testing machine, specimen clamp, etc., have no influence to the measurement signal.

The adjoining photo shows an EXD 15-0,5 diametral Extensometer attached to an diameter 8mm round specimen

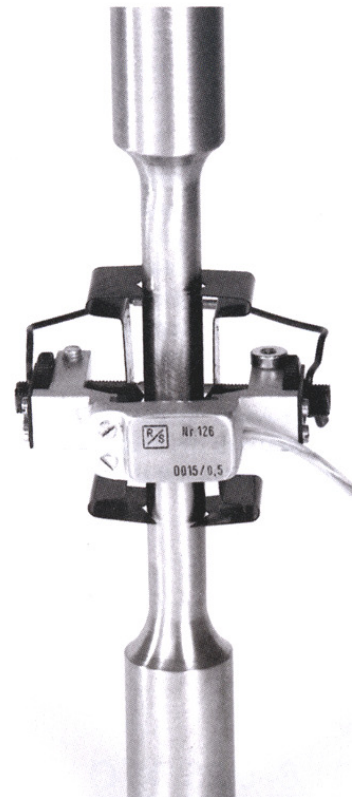

For diametral and axial deformations to be measured, two Extensometers can be applied to one specimen at the same time.

The combination is shown here. It is an axial EXA 50-5 Extensometer and a diametral EXD 15-0,5 Extensometer, each operating separately, with no mechanical connection between them.

There is no mechanical connection between both systems. By that coupling errors due to twist forces and reciprocal vibrations are impossible.

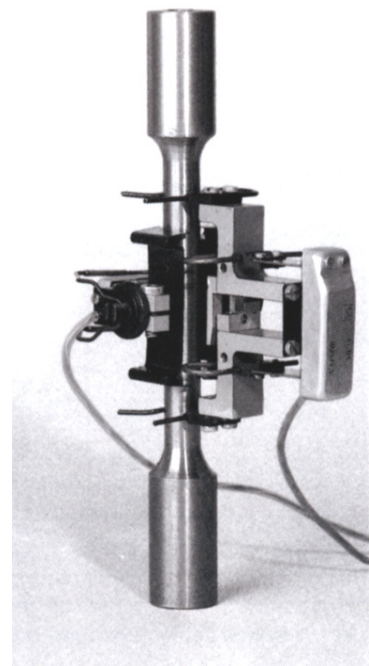

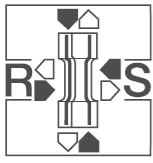

EXD Extensometers are supplied as:

- Extensometer in storage case with 500 mm cable and lemosa plug.
- Retainer plates, two for each round and flat specimens, with adjusting springs.
- Hex spanner for tightening adjusting screw clamping.
- Press-on spring enabling Extensometer to match specimen changes.
- Two retainer plates, with adjusting nuts and stops to prevent overstretching.
- Screw driver.
- Nylon string, to secure Extensometer.
- Data sheet giving all Extensometer-specific data as regards hysteresis, measurement error , and sensitivity.

X = - 80° C - +120° C
 O = -270° C - +220° C
 U = -270° C - +300° C (momentary)

Ordering information:

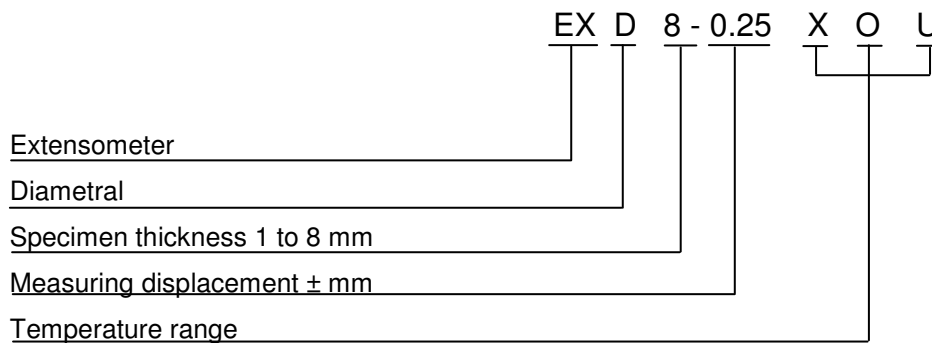

Model-Type x/o/u Version	Specimen Thickness Adjustment Range [mm]	Measuring Displacement [mm]	Measuring Error of Full Scale [± %]	Natural Frequency [Hz]	Weigth [g]	Dimensions		
						L [mm]	B [mm]	H [mm]
EXD 8-0,25	1 - 8	± 0,25	± 0,35	90	14	40	32	28
EXD 8-0,5	1 - 8	± 0,5	± 0,35	90	14	40	32	28
EXD 8-1	1 - 8	± 1	± 0,35	80	16	40	32	32
EXD 15-0,5	5 - 15	± 0,5	± 0,35	90	20	51	39	36
EXD 15-1	5 - 15	± 1	± 0,35	90	20	51	39	36
EXD 15-1,5	5 - 15	± 1,5	± 0,35	80	22	51	39	39
EXD 30-1,25	15 - 30	± 1,25	± 0,35	90	26	73	47	45
EXD 30-2,5	15 - 30	± 2,5	± 0,35	90	26	73	47	45
EXD 30-4	15 - 30	± 4	± 0,35	80	29	73	47	49
EXD 45-2	30 - 45	± 2	± 0,35	70	41	95	53	65
EXD 45-4	30 - 45	± 4	± 0,35	70	41	95	53	65

All measuring errors include hysteresis and nonlinearity related to full scale. Alternating loads are liable to increase measuring errors. Subject to modifications.

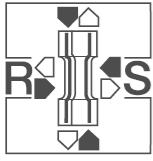

Series EXH high temperature Extensometers

To perform material tests at temperatures up to 1200° SANDNER offers series of Extensometers capable of acquiring tensile, compression and fracture mechanical data at temperatures up to 1200°C. As option rods for temperatures up to 1800° are available. All series EXH Extensometers can be connected for measurement to radiation furnaces or three-zone heating chambers. The measurement data are transmitted from the specimen through the furnace to the Extensometer by two ceramic rods with 90° tips fitted at both ends. Ceramic rods can be reground by using special abrasive discs. Extensometers can be fitted by holders either at the furnace or the machine frame. The Extensometer is provided with a special spring, enabling it to be attached elastically to the heat chamber or machine frame.

Thus motions at the machine are not registered as measurement errors by the Extensometer. This spring in connection with two knurled nuts is pressing the transmission rods quickly and securely to the specimen. In case of, if hard materials are tested, the ceramic rods should slip, a special punching device, from our range of accessories, is available, to prevent this slipping. This will provide on the specimen two centring points on the specimen to accommodate the rod tips. A heat screen protects Extensometers from excessive heat

Included in delivery are:

- Extensometer in storage case with 500 mm long cable and lemosa plug.
- Two ceramic rods with holders an special press-on and compensating spring.
- Heat screen with press-on screws and four knurled nuts.
- Two Extensometer attachment clamps.
- Data sheet giving all Extensometer-specific data as regards hysteresis, measurement error and sensivity.

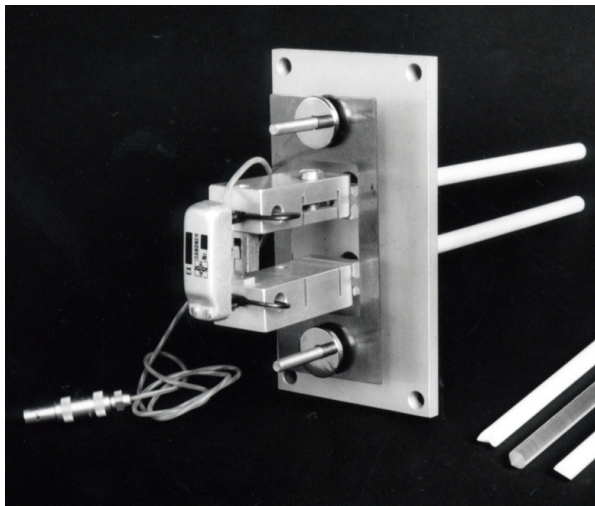

Pic. 1 Standard-high-temperature Extensometer EXH 25-2,5A

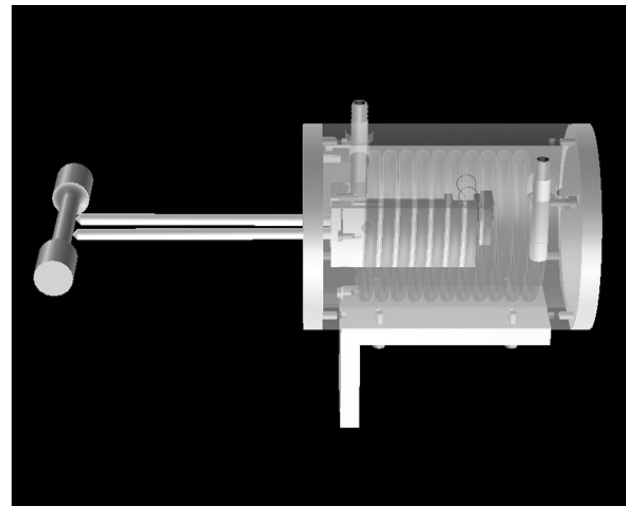

Pic. 2 Special-axial-torsion-high-temperature-Extensometer EXH 16-0,5 AT, with closed or open coolant circulation including adjusting construction for pressing the Extensometer to the specimen.

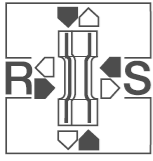

Ordering Information:

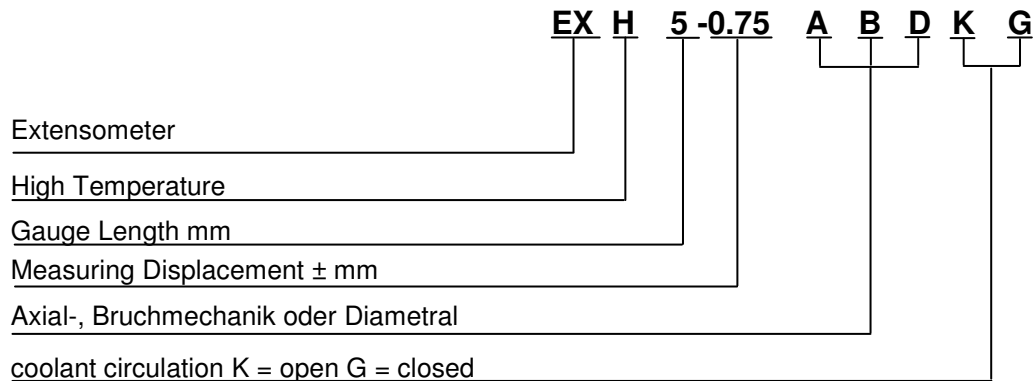

Model-Type Available In A or B	Gauge Length [mm]	Measuring Displacement [mm]	Measuring Error of Full Scale [± %]	Natural Frequency [Hz]	Activation Force [N]	Weigth [g]	Temperature Range [°C]	Dimensions		
								L [mm]	B [mm]	H [mm]
EXH 15-0,75A	15	± 0,75	0,3	150	2	≈100	1200/1800	110	60	240
EXH 15-1,5A	15	± 1,5	0,3	150	2	≈100	1200/1800	110	60	240
EXH 15-3A	15	± 3	0,3	150	2	≈100	1200/1800	110	60	210
EXH 15-6A	15	± 6	0,3	150	2	≈100	1200/1800	110	60	210
EXH 20-1A	20	± 1	0,25	150	2	≈100	1200/1800	110	60	210
EXH 20-2A	20	± 2	0,25	150	2	≈100	1200/1800	110	60	210
EXH 20-4A	20	± 4	0,25	150	2	≈100	1200/1800	110	60	240
EXH 25-1,25A	25	± 1,25	0,25	150	2	≈100	1200/1800	110	60	210
EXH 25-2,5A	25	± 2,5	0,25	150	2	≈100	1200/1800	110	60	210
EXH 25-5A	25	± 5	0,25	150	2	≈100	1200/1800	110	60	240
EXH 30-1,5A	30	± 1,5	0,25	150	2	≈100	1200/1800	110	60	210
EXH 30-3A	30	± 3	0,25	150	2	≈100	1200/1800	110	60	210
EXH 30-6A	30	± 6	0,25	150	2	≈100	1200/1800	110	60	240
EXH 50-10A	50	± 10	0,25	150	3	≈100	1200/1800	110	60	256

All measuring errors include Hysteresis and Nonlinearity related to full scale. Alternating loads are liable to increase measuring errors. Subject to modifications.

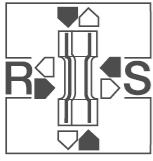

Extensometer-Kits

In order to enable a single Extensometer to cover a wide spectrum of test applications, we have developed a full range of kits for use in touch with or basic unit. This enables you to convert an Extensometer with the accordant kit to an diametral, high-temperature ,etc. type.

This however will require a check for hysteresis, sensitivity and linearity, which may be performed by means of a calibrating device from our range of accessories.

If you don't find the desired type please don't hesitate to contact us.

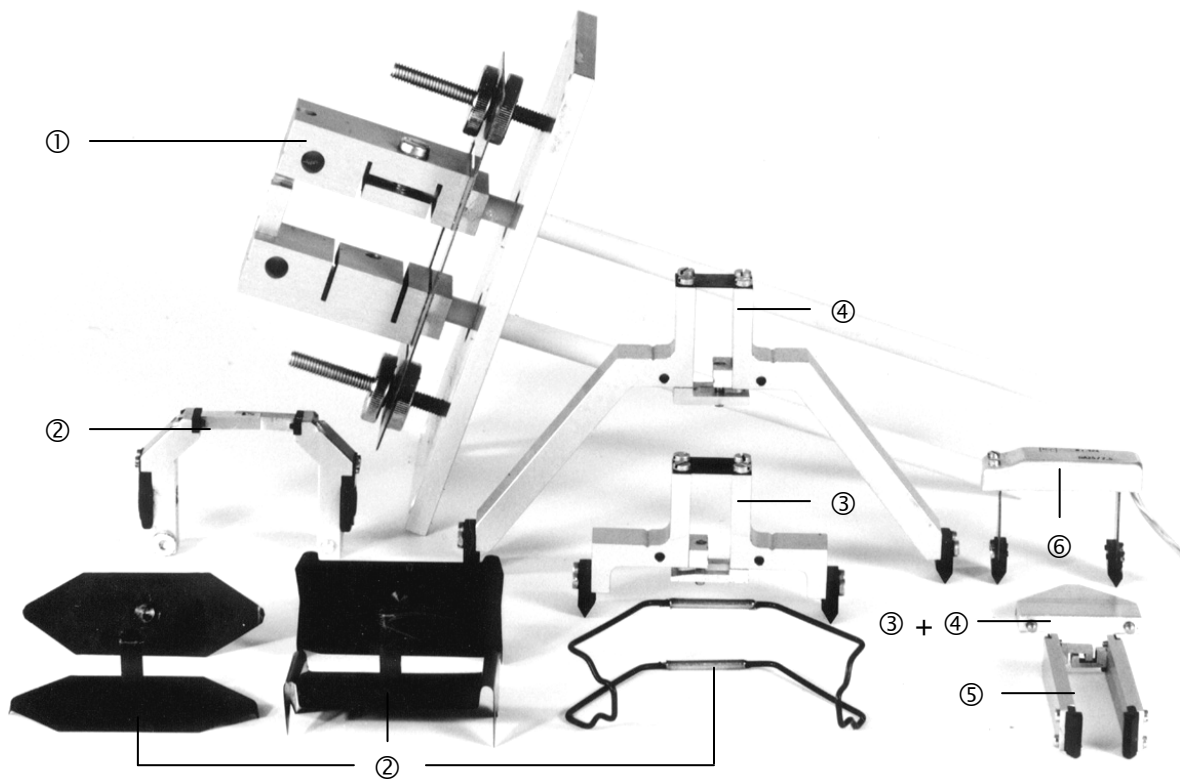

- ① High temperature kit (H 25-1,25)
- ② Diametral kit (D 30-1,25)
- ③ + ④ Gauge length extenders 50 mm + 100 mm (A 50-5/A 100-10)
- ⑤ Measuring displacement extension (A 10-5)
- ⑥ Basic Extensometer 25 mm with axial knife edges (G 25-2,5 + A 25)

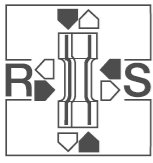

Extensometers Kits and Basic Devices

All basic devices in Design X are available for temperatures up to 120 °C.
 All basic devices in Design O are available for temperatures up to 220 °C.
 All basic devices in Design U are available for temperatures up to 300 °C (momentary).

Ordering Example: Existing extensometer, EXA 10-1
 Required version, EXD 15-1,5 = Kit D 15-1,5

Basic Model x/o/u		EX 10-0,25	EX 10-0,5	* EX 10-1	EX 10-2	* EX 10-5
Accessory Kit	A10	±0,25	±0,5	±1	±2	±5
	A15	±0,5	±1	±2	±4	
	R10	±0,25	±0,5	±1	±2	±5
	D8	±0,25	±0,5	±1		
	D15	±0,5	±1	±1,5		
	H15A	±0,75	±1,5	±3 +6		

Gauge Length in [mm]				
Measuring Displacement in [mm]				

Basic Model x/o/u		EX 25-0,625	EX 25-1,25	* EX 25-2,5	EX 25-5	* EX 25-10
Accessory Kit	A20	±0,625	±1,25	±2,5	±5	±10
	A25	±0,625	±1,25	±2,5	±5	±10
	A30	±0,625	±1,25	±2,5	±5	±10
	A40			±4		
	A50			±5		
	A60			±6		
	A70			±7		
	A80			±8		
	A90			±9		
	A100			±10		
	R20	±0,625	±1,25	±2,5	±5	±10
	R25	±0,625	±1,25	±2,5	±5	±10
	R30	±0,625	±1,25	±2,5	±5	±10
	D30	±1,25	±2,5			
	D45	±2	±4			
	H20A	±1,25	±2,5			
	H25A	±1,25	±2,5 +5			
	H30A	±1,25	±2,5 +5			
	H50A			±10		

Subject to modifications.

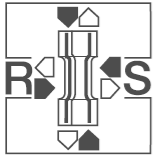

Series KEM – KEE – KED Calibrators

are based on our long experience in Extensometer manufacturing, considering customer preferences. They are used for the calibration of signal conditioners and belonging Extensometers of different construction and producers, such as axial, diametral, Clip-on, high temperature-Extensometers etc.

The above resulted in a calibration system in three different versions, to be selected as required according to the application.

Selection should be made on the main criteria that the accuracy of the calibrator should be considerably higher than the accuracy of the Extensometer to be checked.

Experience shows that checking of the signal conditioners and belonging Extensometers is absolute necessary from time to time depending on the test conditions. This applies especially when converting Extensometers and exchanging wearing parts.

Calibrators developed by SANDNER are ideally suited to match requirements of different accuracy classes in an economical way.

Special features of the mechanical design for calibrators

- High stiffness of measuring base avoids miscalibration by Extensometer activation force.
- Backlash and jerk free adjustment of measuring carriage as a result of special linear ball slides. Any backlash which may occur after frequent use can be compensated by a backlash compensation screw.
- Movement of the measuring carriage by means of a micrometer spindle with a similar accuracy to the calibrator system.
- Backlash free coupling of micrometer spindle to the measuring carriage by a special hardened ball button.
- No angle (cosine) error as in calibrators of an other type, as a result of their geometrical design and or by manufacturing tolerances as well as wear.
- All Extensometer calibrations can be arranged in the horizontal position of the measuring carriage.
- The modular conception allows the later upgrading of a calibrator model KEM or KED.

Model KEM

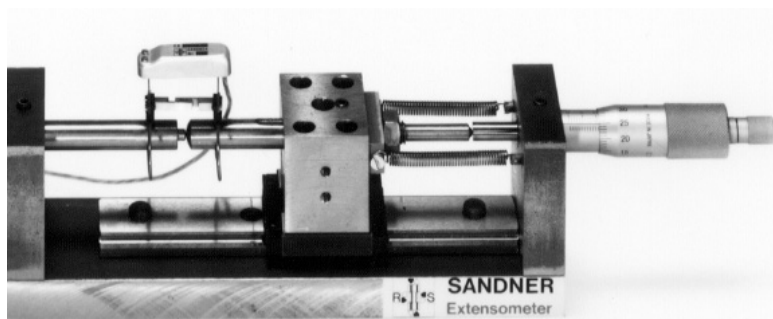

This is a simple calibrator with measuring carriage adjustment by a micrometer spindle with reading accuracy $\pm 1 \mu\text{m}$.

For Extensometers starting from 5% nominal displacement.

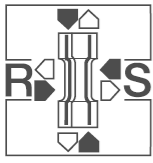

Model KEE

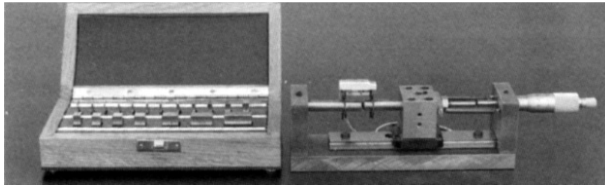

This version contains the model KEM as described overleaf complete with a set of Class 0 slip gauges, with a storage case as shown at the photo. Combination of model KEM and the slip gauges assure an accuracy of $\pm 0,5 \mu\text{m}$.

Applications: For Extensometers starting from 2,5% nominal displacement.

Model KEE



This model is available in two versions:

KED-1

For calibration starting from 2,5% nominal Extensometer displacement, measuring accuracy $\pm 0,5 \mu\text{m}$.

KED-2

For calibration starting from 1% nominal Extensometer displacement, measuring accuracy $\pm 0,1 \mu\text{m}$ at $20^\circ\text{C} \pm 1^\circ\text{C}$.

Both versions offer special advantages, if a fast and simple calibration is required with high accuracy.

The calibrators make possible very small calibration steps of $0,05 \mu\text{m}$ for direct reading on a 7-digit display integrated in the frequency counter. The unit is equipped with a V24/RS 232-C interface for data transfer, for further analysis, correction, storage, etc..

By the fine step calibration it is possible to obtain a high resolution of a part of the strain range of the Extensometer for certain tests.

This is possible in conjunction with appropriate use of the gain of the signal conditioner.

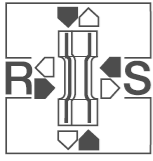

Scope of supply of models KEM – KEE – KED

Standard mechanical components with all accessories, as described to the different models, are supplied in a storage case.

The calibrators are ready for the calibration of axial and crack mouth opening Extensometers without any additional components. Fixtures are available for use with diametral, high temperature and other special Extensometers.

The models KED-1 and KED-2 are supplied in addition with:

1 digital frequency counter, 7 digit type ND 281 respectively, installed in a portable case including interface V24 / RS232-C. mains supply 220 to 240 V \pm 10%, 48-62 Hz.

1 digital optical incremental encoder type MT 60, measuring range 60 mm for KED-1

1 digital optical incremental encoder type CT 60, measuring range 60 mm for KED-2